

thecarversite.com

This manual is either an original scan from tech's who worked at Carver corp, donated by forum members, or both. These manuals are NOT intended for re-sale. If you purchased a 'Carver Manuals' disc on ebay or another auction site, and it has this material on it, you were ripped off!

Please report any resale of this material to us at thecarversite.com

thecarversite.com

CARVER

P R O F E S S I O N A L

BY PHOENIX GOLD 

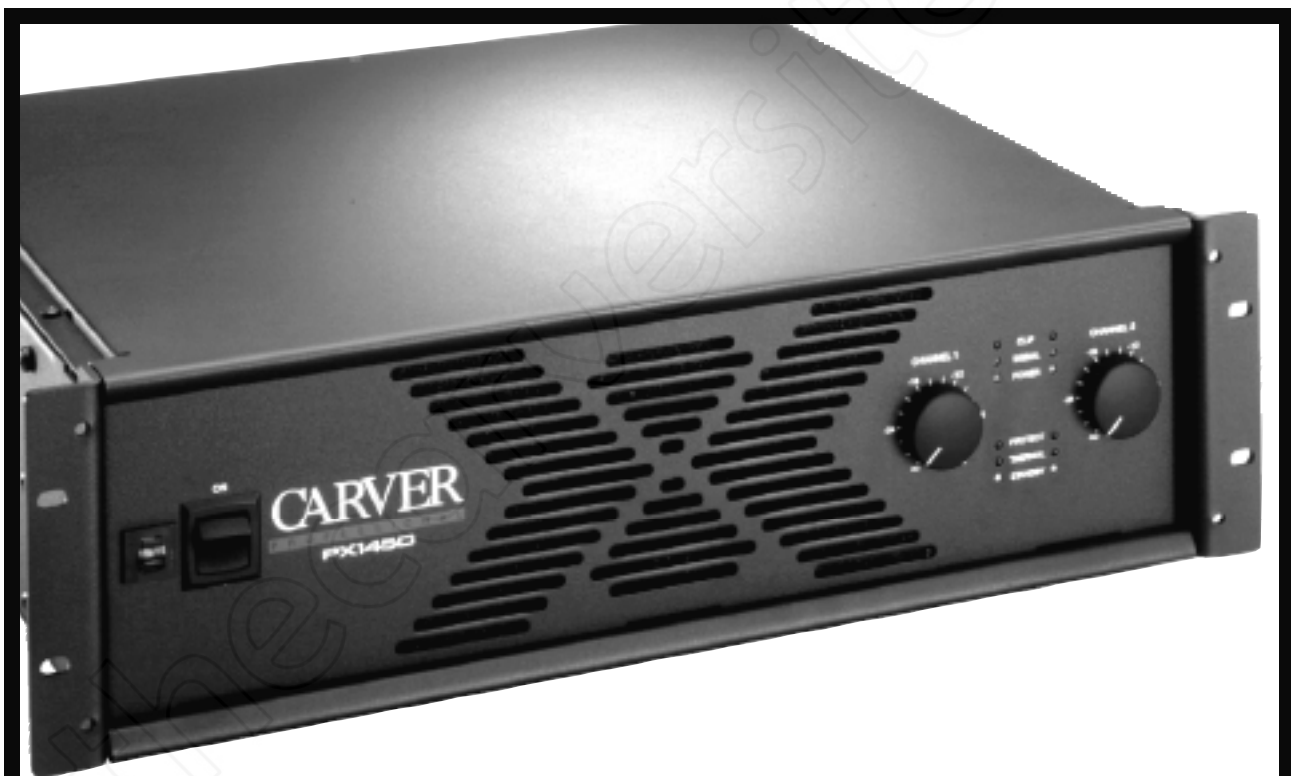

px850/1450

Professional Stereo Power Amplifier

Safety Information





	<p>CAUTION</p> <p>RISK OF ELECTRIC SHOCK</p> <p>DO NOT OPEN</p>		 <p>The lightning flash with arrowhead symbol within an equilateral triangle is intended to alert the user to the presence of uninsulated "dangerous voltage" within the product's enclosure, that may be of sufficient magnitude to constitute a risk of electric shock to persons.</p>
<p>CAUTION: TO REDUCE THE RISK OF ELECTRIC SHOCK</p> <p>DO NOT REMOVE COVER (OR BACK)</p> <p>NO USER-SERVICEABLE PARTS INSIDE</p> <p>REFER SERVICING TO QUALIFIED SERVICE PERSONNEL</p>			 <p>The exclamation point within an equilateral triangle is intended to alert the user of the presence of important operating and maintenance (servicing) instructions in the literature accompanying the appliance.</p>

Table Of Contents

Introduction	2	Installation (continued)	
Unpacking and Paperwork.....	2	Input Sensitivity	10
Features and Specifications		Output Wiring.....	11
PX850.....	3-4	Polarity	11
PX1450.....	5-6	Bridged Mono.....	11
Controls and Features	7-8	Parallel Mono	11
Installation and Operations		70V Distribution Systems.....	11-12
Location and General Precautions	9	Signal Smart Standby Circuit.....	12
Mechanical Considerations	9	Operating Tips.....	13
Rear Support.....	9	Care and Service Assistance	13
Thermal Considerations	9	Configurable Gain Controls.....	14
AC Power Considerations.....	9	In Case of Difficulty.....	15
Magnetic Leakage Considerations.....	9	Warranty Information.....	16
Input Wiring	9	Accessories.....	17-18

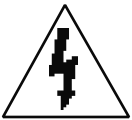
Introduction

PX850
PX1450

Congratulations on your purchase of a new Carver Professional Power Amplifier. The PX850 and PX1450 are designed for any pro audio application. The PX Series is the first line designed and produced by Carver Professional, a division of Phoenix Gold International, Inc. It combines the Pro Audio experience and sonic heritage of Carver Professional with the performance, manufacturing quality and attention to detail that has defined Phoenix Gold International. Thank you for placing your confidence in Carver Professional and Phoenix Gold. We know your amplifier will provide many years of dependable service and reliable sound reproduction.

Please read all of this manual, especially the Safety Warnings, before operating your amplifier.

Unpacking and Paperwork

Carefully unpack the amplifier and keep the original carton and packing materials for future moving, shipment or long-term storage. After opening the box, please check for any visible signs of damage that were not apparent from the outside of the box. If you do encounter what appears to be concealed damage, please consult your Carver Professional Dealer before installing the unit.

Important Paperwork

Make sure to save your sales receipt. Your receipt is extremely important to establish the duration of your Limited Warranty and for insurance purposes. Next, make a note of the serial number which is located on the back of the amplifier. Record it in the space provided below for convenient reference.

Model: _____PX850_____PX850BR_____PX850SP
_____PX1450_____PX1450BR_____PX1450SP
Serial Number: _____
Purchased at: _____
Date: _____

Finally, take a moment to fill out and return the Warranty Registration Card packed with the amplifier and return it to Carver Professional. This will allow us to keep you informed about new products as they become available.

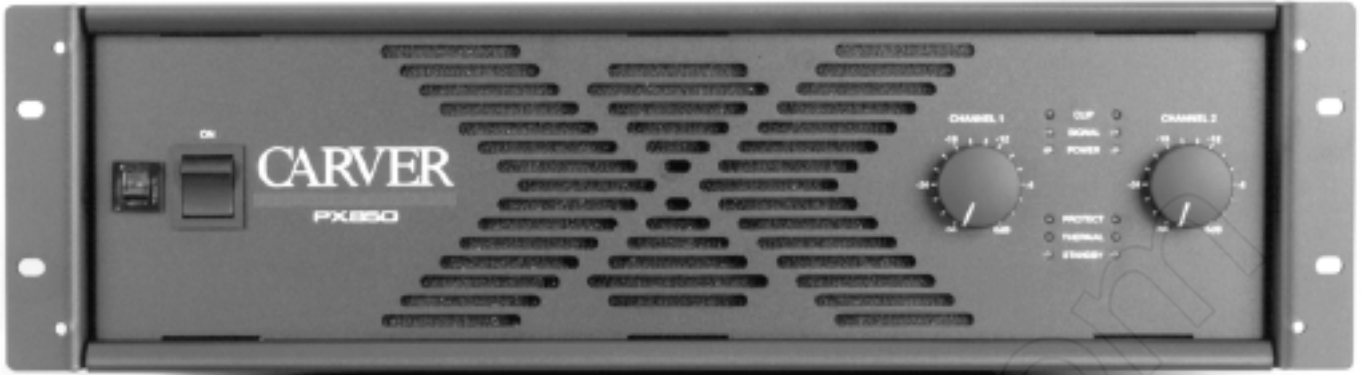

PX850

FEATURES

- 250W per channel into 8 ohms
425W per channel into 4 ohms
525W per channel into 2 ohms
- Three connector versions available:
 - Standard - Neutrik™ combi inputs with Binding Post outputs
 - BR Version - Barrier Strip inputs and outputs
 - SP Version - Neutrik™ combi inputs with Neutrik™ Speakons™ and Binding Post outputs
- Independent 41 detent Level Controls for CH1 & CH2
- Externally configurable for Parallel Mono mode to operate both channels with a mono signal
- Externally configurable for Bridged Mono mode to combine the power of both channels into a higher powered mono channel
- Externally configurable input sensitivity @ 0.775V, 1.5V or fixed +28dB gain
- Protection circuitry includes DC Fault, Thermal, and Short Circuit
- Power Ready, Signal Present, Clip, Protect, Thermal and Standby indicators for each channel
- Variable Speed Fan
- Front or Rear Gain Controls (field configurable)
- Signal Smart Standby Circuitry. Power saving feature which automatically turns off or on the amplifier based on the presence of a signal and the position of the threshold adjustment
- RAMP optional computer monitoring port

PX850BR



SPECIFICATIONS



PX850
PX1450

Continuous Average Output Power, both channels driven:	(20Hz to 20kHz, with no more than 0.1% THD) 250 watts per channel into 8 ohms, 425 watts per channel into 4 ohms, 525 watts per channel into 2 ohms,	Signal-to-Noise Ratio:	>106dB, A-weighted, ref. to rated power into 8 ohms
Bridged-mono operation:	850 watts into 8 ohms at 1kHz, with no more than 0.1% THD	Slew Rate:	70V / μ S
Parallel-mono operation:	260 watts into 8 ohms from 20Hz to 20kHz, with no more than 0.1% THD	CMRR:	>80dB @ 1kHz
Dynamic Headroom:	>2.0dB	Current Consumption:	84w @ idle, 525w with musical program, 840w @ full power into 8 ohms (continuous), 1540w @ full power into 4 ohms (continuous)
Frequency Response:	20Hz to 20kHz (\pm 0.1dB)	Display:	6 LED indicators per channel; red CLIP, yellow SIGNAL READY, green ON, red PROTECT, red THERMAL, yellow STANDBY
Channel Separation:	>65dB @ 1kHz	Size (H x W x D):	5.75" (3u) x 19" x 15.38" 133.4mm x 483mm x 390.6mm
Damping Factor:	<600 @ 10-400Hz ref. to 8 ohms	Net Weight:	46.0lbs. (20.9kg)
Input Impedance:	20K balanced	Shipping Weight:	52lbs. (23.64kg)
Sensitivity:	.775V, 1.5V for rated power 4 ohms, or fixed gain of +28dB	Due to ongoing research and development, all specifications and features are subject to change without notice.	
Gain:	34.5dB, 28.8dB, or 28dB fixed dependent on sensitivity	Barrier strip version available. Order PX850BR Neutrik Speakon™ version available. Order PX850SP Handle Kit available. Order PX4HK	
Input Overload:	+18dBu	The PX850 Series is available in 100V, 120V and 230V 50/60Hz.	
THD:	<0.1%		
IM Distortion:	<0.1%		

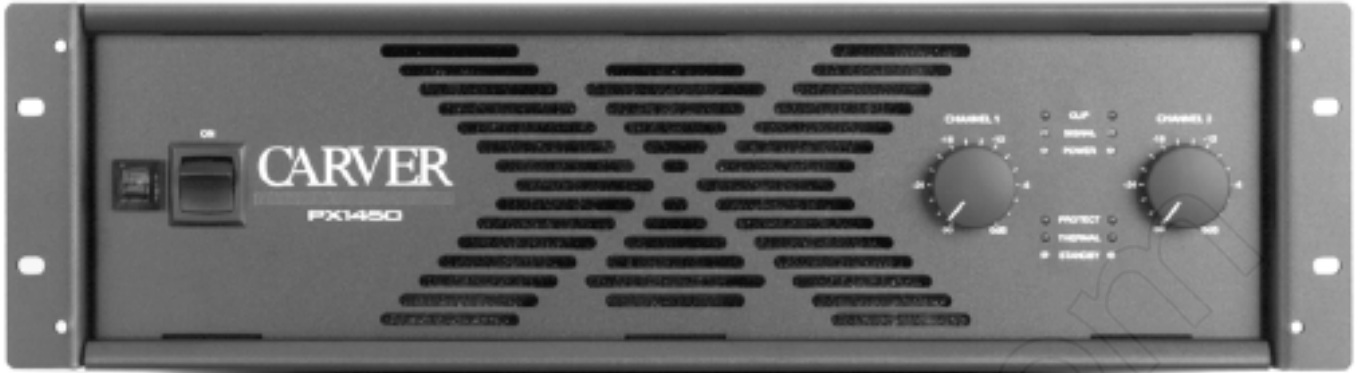

PX1450

FEATURES

- 375W per channel into 8 ohms
725W per channel into 4 ohms
1000W per channel into 2 ohms
1450W mono into 8 ohms
2000W mono into 4 ohms
- Three connector versions available:
 - Standard - Neutrik™ combi inputs with Binding Post outputs
 - BR Version - Barrier Strip inputs and outputs
 - SP Version - Neutrik™ combi inputs with Neutrik™ Speakons™ and Binding Post outputs
- Independent 41 detent Level Controls for CH1 & CH2
- Externally configurable for Parallel Mono mode to operate both channels with a mono signal
- Externally configurable for Bridged Mono mode, to combine the power of both channels into a higher powered mono channel.
- Externally configurable input sensitivity @ 0.775V, 1.5V or fixed +28dB gain
- Protection circuitry includes DC Fault, Thermal and Short Circuit
- Power Ready, Signal Present, Clip, Protect, Thermal and Standby indicators for each channel
- Variable Speed Fan
- Front or Rear Gain Controls (field configurable)
- Signal Smart Standby Circuitry. Power saving feature which automatically turns off or on the amplifier based on the presence of a signal and the position of the threshold adjustment
- RAMP optional computer monitoring port

PX1450BR



SPECIFICATIONS



PX850
PX1450

<p>Continuous Average Output Power, both channels driven: (20Hz to 20kHz, with no more than 0.1% THD) 375 watts per channel into 8 ohms, 725 watts per channel into 4 ohms, 1000 watts per channel into 2 ohms</p> <p>Bridged-mono operation: (1kHz, with no more than 0.1% THD) 1450 watts into 8 ohms, 2000 watts into 4 ohms</p> <p>Parallel-mono operation: 375 watts into 8 ohms from 20Hz to 20kHz, with no more than 0.1% THD</p> <p>Dynamic Headroom: >2.0dB</p> <p>Frequency Response: 20Hz to 20kHz (± 0.1dB)</p> <p>Channel Separation: >65dB @ 1kHz</p> <p>Damping Factor: <600 @ 10-400Hz ref. to 8 ohms</p> <p>Input Impedance: 20K balanced</p> <p>Sensitivity: .775V, 1.5V for rated power 4 ohms, or fixed gain of +28dB</p> <p>Gain: 36.8dB, 31.1dB, or 28dB fixed dependent on sensitivity</p> <p>Input Overload: +18dBu</p> <p>THD: <0.1%</p> <p>IM Distortion: <0.1%</p>	<p>Signal-to-Noise Ratio: >106dB, A-weighted, ref. to rated power into 8 ohms</p> <p>Slew Rate: 70V/μS</p> <p>CMRR: >80dB @ 1kHz</p> <p>Current Consumption: 120W @ idle, 750w with musical program, 1200w @ full power into 8 ohms (continuous), 2200w @ full power into 4 ohms (continuous)</p> <p>Display: 6 LED indicators per channel, Red CLIP, Yellow SIGNAL, Green POWER, Red PROTECT, Red THERMAL, Yellow STANDBY</p> <p>Size (H x W x D): 5.75" (3u) x 19" x 15.38" 133.4mm x 483mm x 390.6mm</p> <p>Net Weight: 58.2lbs. (26.5kgs)</p> <p>Shipping Weight: 64lbs. (29.09kgs)</p> <p>Due to ongoing research and development, all specifications and features are subject to change without notice.</p> <p>Barrier strip version available. Order PX1450BR Neutrik Speakon™ version available. Order PX1450SP Handle Kit available. Order PX4HK</p> <p>The PX1450 Series is available in 100V, 120V and 230V 50/60Hz.</p>
--	--

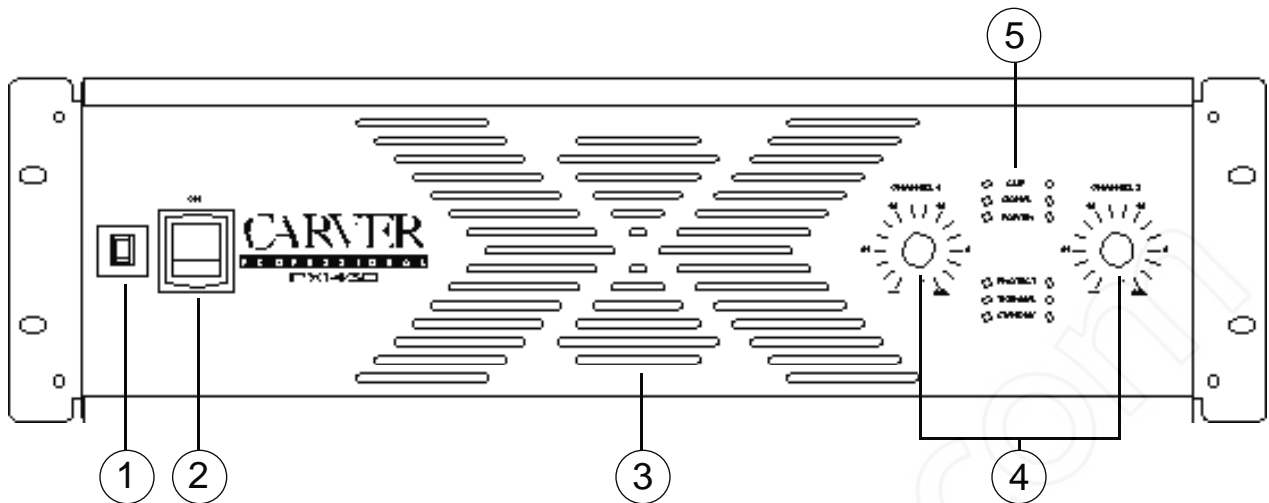

Controls And Functions

1. CIRCUIT BREAKER.

This protection device will trip if the line current exceeds the rating of the circuit breaker, causing the amplifier to shut down completely. This operates the same as a standard line fuse, except that it is resettable from the front panel after cooling down for a few seconds.

2. POWER SWITCH.

When this switch is engaged, the power turns ON, the PROTECT lights flash red and the Power indicators illuminate. Be sure all connections are made and double-checked before switching the power amplifier on.

3. EXHAUST VENT.

Releases warm air pushed from heat sinks by fan.

4. CH1 / CH2 LEVEL CONTROL.

The 41 detent controls are used to adjust the input level of each channel. When the controls are fully clockwise the amplifier operates at maximum gain. Turning the controls counter-clockwise attenuates the input signal. See page 14 for instructions on how to move these controls to the back panel.

5. CH1 / CH2 STATUS INDICATORS.

STANDBY- illuminates yellow when Signal Smart Standby circuit has been activated. THERMAL- illuminates red when excessive heatsink and/or transformer temperature has been detected. PROTECT- illuminates red when the power switch is first turned on, or whenever there is a fault condition detected. These fault conditions include excessive DC offset or over current at output (VI limit). DC output protection is provided by a relay. POWER- illuminates green when power is on and amplifier is ready to operate. SIGNAL- illuminates yellow when power is on and signal is present. CLIP- illuminates red when the output begins to clip.

NOTE: The relays operate independently for each channel. Therefore it is possible for one channel to operate normally while the other is in "protect" mode.

6. CH1 / CH2 LEVEL CONTROLS.

Optional rear panel placement.

7. INPUT SENSITIVITY SWITCH.

0.775V, 1.5V or fixed +28dB gain.

8. CH1 / CH2 INPUT CONNECTORS.

Neutrik™ combi connectors will accept either XLR or 1/4" TRS (tip-ring-sleeve) connectors. They can be used with balanced or unbalanced signals (see input wiring on page 9 for more information).

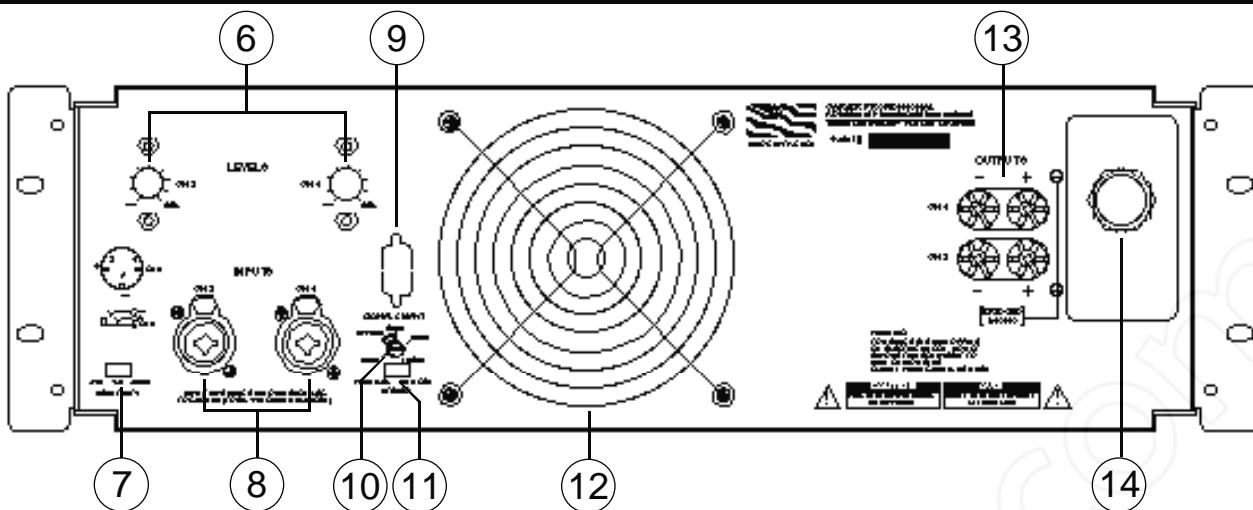

8b.CH1 /CH2 INPUT CONNECTORS.

6 position barrier strip. Horizontal connection accepts 8mm spades. (see page 10 for more information).

9. FUTURE OPTION.

Knockout for connector (TRS232) for external computer monitoring.

10. SIGNAL SMART THRESHOLD CONTROL.

Sets desired signal level for activation of Standby circuit. (See page 12 for more information)

11. BRIDGED OPERATION.

The OUTPUT CONFIGURATION switch is used to select between NORMAL STEREO operation, PARALLEL MONO operation, or BRIDGED MONO operation. For NORMAL STEREO operation, use CH 1 and CH 2 inputs. For PARALLEL MONO or BRIDGED MONO operation, use CH 2 input only (see page 11 for more information about Bridged Operation).

12. FAN.

Variable speed fan. Draws cool air in from back of amplifier, across heatsinks and vents out front panel.

13. CH1/CH2 SPEAKER OUTPUTS.

Multi-way binding posts are used to connect the loudspeakers to the amplifier outputs. The red terminals are the signal connection (+), and the black terminals are the signal return connection (-). The black terminals are internally tied to signal ground.

13b. CH1/CH2 SPEAKER OUTPUTS, BR VERSION.

4 position barrier strips. Horizontal connection accepts 8mm spades.

13c. CH1/CH2 SPEAKER OUTPUTS, SP VERSION.

Neutrik™ Speakon™ connectors plus multi-way binding posts.

14. POWER CORD.

Connect to a properly configured outlet providing the line voltage specified for your model.

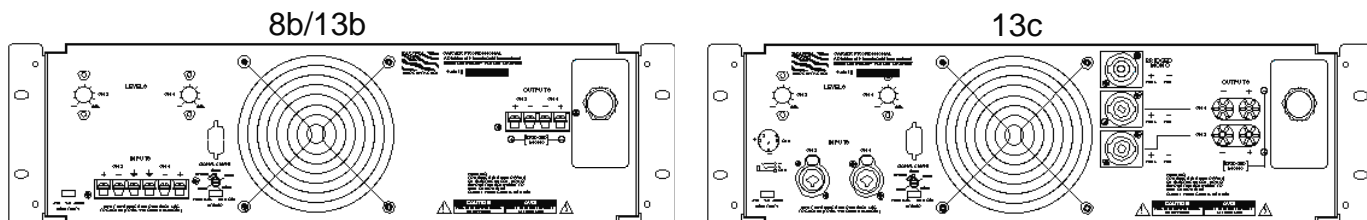

Installation

Location and General Precautions

Observe the following precautions when choosing a location for your amplifier.

A. Do not expose the unit to rain or moisture. If a fluid or foreign object should enter the unit, disconnect the power plug and contact an authorized dealer or service center. Do not pull out the plug by pulling on the cord; grasp the plug firmly.

B. Protect from heat and allow adequate ventilation. Place away from direct sources of heat, such as heating vents and radiators. All components produce some heat during operation, so make sure that the ventilation holes are not covered and that air is allowed to circulate freely behind, beside and above the unit. Excessive heat is the single greatest source of both short-term and long-term component failure.

Mechanical Considerations

The PX850 and PX1450 require three rack space units (5.25") and a depth of 15.38" inside the rack, including the rear supports. Secure the unit mechanically using four screws with washers to prevent marring the front panel. Neoprene rubber washers are a good choice because they grip the screw head and prevent them from backing out when vibrated or transported.

Rear Support for Road Applications

If the PX amplifier is rack-mounted and the rack is transported, mechanical support for the rear of the amplifier is required. This could take the form of a shelf across the rear of the amplifier or brackets that engage the rear of the unit. Rear support is recommended in all PX amplifier installations.

Thermal Considerations

When the PX850 or PX1450 is used free-standing, no thermal considerations are necessary other than keeping the ventilation holes open. If the amplifiers are rack-mounted, ensure that adequate ventilation exists in front of and behind the amplifier. When several amplifiers are mounted together in a rack, you may need to provide air inlets from the outside of the rack. The PX amplifiers are fan cooled. The fan is internally mounted so that it draws air from the rear and exhausts it out the front. The PX amplifiers may be stacked directly on top of each other without spacer panels. If the amplifiers are used with other amplifiers, ensure that the heat output from the other amplifiers doesn't interfere with the ventilation of the PX amplifier (or vice versa).

AC Power Considerations

Ensure that the PX amplifier is plugged into an outlet capable of supplying the correct voltage specified for your model and enough current to allow full-power operation of all the amplifiers plugged into it. The current demand of a power amplifier varies depending on several factors, including the impedance of the load, the output level of the amplifier, and the crest factor and duty cycle of the program material. Under typical conditions reproducing rock music, with both channels driven into a 4 ohm load to the point where musical peaks are just at the clipping point, the amplifiers require the following average currents:

PX850: 6.0 amps for 120V versions, 3.2 amps for 230V versions

PX1450: 8.0 amps for 120V versions, 4.2 amps for 230V versions

Magnetic Leakage Considerations

The PX amplifiers may be mounted without concern for magnetic flux leakage, within the confines of common sense. For example, it's not a good idea to mount any power amplifier near a microphone input transformer or magnetic storage media.

Input Wiring

(see page 17 for recommended Carver Professional Accessories)

Standard Version

The Neutrik™ combi connectors will accept either 1/4" phone jacks or XLR connectors. The input signal can be used with either unbalanced shielded single conductor or balanced shielded 2 conductor cables. Use shielded coaxial cable to conduct the signal from the source (i.e. mixer, equalizer, CD player) to the amplifier.

For balanced operation:

1/4-inch phone jack: Use a 3-conductor TRS (tip-ring-sleeve) 1/4" phone plug. The tip of the plug carries the "+" (high, noninverting) side of the signal, the ring carries the "-" (low, inverting) side of the signal and the sleeve is ground (see Figure A).

XLR: Use a male XLR connector. Pin 2 carries the "+" (high, non-inverting) side of the signal, Pin 3 carries the "-" (low, inverting) side of the signal, and Pin 1 is ground (see Figure B).

For unbalanced operation:

1/4-inch phone plug: Use a 2-conductor (Tip-Sleeve) 1/4" phone plug. The tip of the plug carries the signal and the sleeve is ground. The ring connection in the jack is automatically grounded by the sleeve (see Figure C).

XLR: Pin 2 carries the hot side of the signal, and Pin 1 is ground. Short Pin 3 to Pin 1 in order to reference the input differential amplifier for the correct gain (see Figure D).

BR Version

For balanced operation:

Use shielded twisted pair balanced line type cable with crimp-on or solder type 8mm. spade terminals. For either channel connect the "+" (high, non-inverting) side of the signal to the terminal labeled "+" on the Barrier Strip. Connect the "-" (low, inverting) side to the "-" terminal. Connect the shield to ground. (See figure E).

NOTE: confirm which wires are "+" and "-" from the source unit. Refer to the 1/4" plug and XLR instructions for proper configuration if these plugs are used at the source unit.

For unbalanced operation:

Use shielded single conductor coax type cable or twisted pair balanced line type cable with crimp on or solder type spade terminals. Connect the hot side of the signal to the terminal labeled "+" on the barrier strip. Connect the shield to "ground" **and** to the "-" terminal. (see Figure F)

NOTE: The gain remains the same regardless of whether the input is balanced or unbalanced

Input Sensitivity

The input sensitivity of the amplifier is set at the factory to 1.5VRMS for rated output. The input sensitivity can be changed to 0.775VRMS, or +28dB fixed gain by using the switch on the back panel.

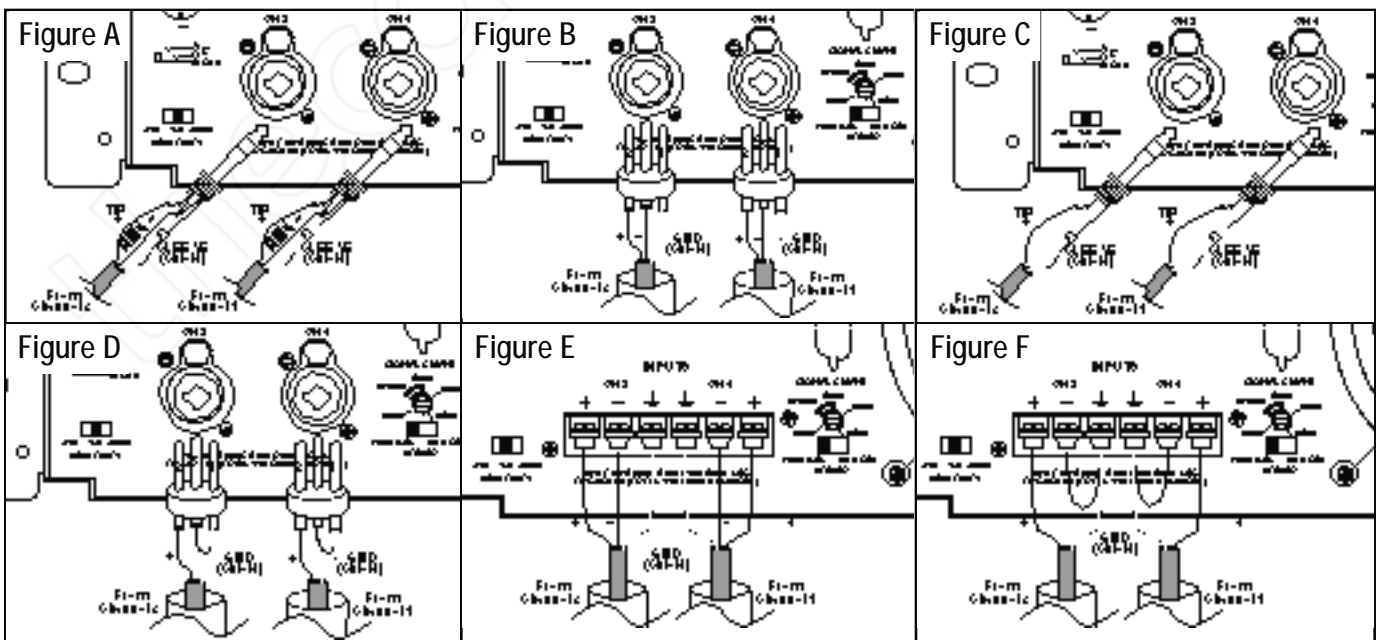

Output Wiring

(See page 17 for recommended Carver Professional Accessories).

Use heavy gauge cable for speaker connections. The greater the distance between the amplifier and the speakers, the larger the diameter the cable should be to minimize power losses across the cable and improve the damping of the speaker. Cable thickness specifications (or gauges) get larger as the cable gets thinner; thus 14-gauge cable is thicker than 16-gauge cable. Use the following as a guide: up to 25 feet use 16 gauge, up to 40 feet use 14 gauge, up to 60 feet use 12 gauge, up to 100 feet use 10 gauge, up to 150 feet use 8 gauge, up to 250 feet use 6 gauge. This will insure that the resistance of the speaker cable is less than 5% of 4 ohms, resulting in a transmission loss of less than 0.5dB. Class 1 (NEC) cable must be used.

Multi-Way Binding Posts: Can accept spade lug, bare wire, or banana connections (except CE approved versions). Be sure that all the fine strands of the cable are twisted together and contained within the connector. If even one strand is loose and can touch the adjacent terminal, a short circuit may result.

Barrier Strip: Use crimp-on or solder type 8mm. spade terminals.

Speakon™: Must use Neutrik™ Speakon™ 4 position female connector NL4FC. Use speaker cable gauges as specified above for optimum performance. Stereo or paralleled configuration for both channels Pin 1 “+” is positive, Pin 1 “-” is negative. Using the Mono Bridge connector, Pin 1 “+” is positive AND Pin 1 “-” is negative.

Polarity

Loudspeakers must be connected with consistent polarity for correct phasing between them. Incorrect phasing will do no physical harm, but frequency response will be affected. The key is to make sure that both speakers connected to the speaker terminals are hooked up the same way. Connect (-) at the speaker outputs to (-) on the back of the speaker, and (+) at the speaker outputs to (+) on the back of the speaker.

Bridged Mono

When in Bridged Mono setting connect the input signal to CH2 input (CH1 input becomes disabled). Connect the speaker(s) to the two (+) speaker terminals. The CH2 (+) terminal is the hot (+)(non-inverting) side, and the CH1 (+) terminal is the low (-)(inverting) side. When connected in this way, each channel “sees” one-half the impedance of the speaker that is connected between them. If an 8 ohm speaker is used, each channel will see a 4 ohm load. Therefore it is not recommended that any load lower than 8 ohms be connected in this mode of operation. Use Parallel Mono operation for lower impedances.

Note: Be sure to set both of the input level controls to the exact same setting for equal power distribution per channel.

CAUTION: In bridged mono operation, the output connections are actually a balanced output configuration. This means that both output terminals have voltage present (neither one may be grounded).

Parallel Mono

To configure the amplifier for parallel-mono operation, change the output configuration switch located on the back panel of the amplifier. Connect input source to CH2 (CH1 gain control is now disabled). Connect speaker to either CH1 or CH2 or both.

Note: To daisy chain the input audio signal to additional amps, a balanced signal Y-adaptor connected to the channel input is recommended.

70V Distribution Systems–PX850

The PX850 can be used to drive 70-volt distribution systems using Carver Professional’s output distribution transformer (available separately from your Carver Professional dealer). Order X0450. Connect one transformer to the output of each amplifier channel to deliver 425 watts (PX850) to the 70-volt system, depending on the impedance of the total system. As with all 70-volt systems, transformers are also required at each loudspeaker. The XO-450A transformer includes a tap for 100-volt systems as well.

70V Distribution Systems–PX1450

The PX1450 has sufficient output voltage capability in stereo mode to drive 70-volt distribution systems without using a step-up transformer at the amplifier. In this configuration, the PX1450 delivers up to 375 watts per channel to the 70-volt system, depending on the impedance of the total system. As with all 70-volt systems, transformers are still required at each loudspeaker. The PX1450 can deliver 375 watts per channel into an 8 ohm impedance (54V line voltage). The price for going direct is having to calculate the new transformer tap values at the new line voltage. Since watts are proportional to the square of the voltage, compute the correction factor by taking the ratio of the square of the line voltages. Then multiply each tap value by this correction factor. For example, choose a transformer that has taps at 10W, 5W and 2.5W when used in a 70.7 volt distribution. Its new tap values when used with a PX1450 are computed as follows:

1. Complete correction factor K:

$$K = 54V^2/70.7V^2$$

$$K = .583$$

2. Apply to tap value:

Marked tap value X K = new tap value

$$10W \times .583 = 5.83W$$

$$5W \times .583 = 2.92W$$

$$2.5W \times .583 = 1.46W$$

When used in a 70.7 volt distribution system, this transformers new tap values are 5.8W, 2.9W, and 1.5W. Note that the 3dB power relationship between each tap still holds true. Similarly, maximum amplifier loading occurs when the sum of the NEW tap values equals the amplifier's output power (375W).

Signal Smart Standby Circuit

Allows amplifier to remain "on", but when signal is not present for 3 minutes, amplifier goes into standby mode. Current draw is reduced, fan shuts down, amp remains in standby until signal returns. Within 50 milliseconds of a signal present, amplifier returns to full power. Signal level for shut down and power up is adjustable by Signal Smart Threshold Control located on rear panel. Unit is shipped with Threshold Control set at "bypass". (See Diagram G for setting levels). The Bypass setting defeats the Signal Smart Standby Circuit and the amplifier remains on at all times. When the indicator is in the -50dB to -20dB range, it will control the amount of signal required to return the amplifier to full power from standby (-50dB requiring a very weak source signal, -20dB requiring a very strong source signal).

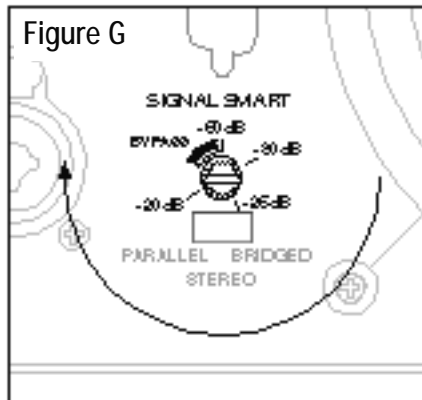

Operating Tips

Using the PX850/PX1450

Once the amplifier has been installed and wired into the system, you are ready to use it. Here are some tips to help you get the most from it.

- Verify that the switches (Output Configuration/Input sensitivity) have been set to the mode that you want.
- Verify that the Signal Smart Standby circuit threshold is set at the level you want.
- When you power the system up for the first time (out of the carton), it's a good idea to start with all of the amplifier level controls turned down, then advance them slowly, one at a time, so that you can confirm that each amplifier channel is operating normally.
- Be sure that the Input Level controls are set sufficiently high to allow the preceding device to drive the amplifier to full output. For most installations, this is wide open (fully clockwise).
- Once you have established settings, it is a good idea to mark them down, either on paper, or on pieces of tape or sticky-dots attached to the amplifier's panel.
- In bi-amplified (multi-amp) systems, it is a good idea to start with the low-frequency amplifiers turned off or down, and to check each frequency range from highest to lowest to ensure that each loudspeaker component is operating correctly.

Care and Service Assistance

Care: Wipe off the PX850/PX1450's front panel and chassis from time to time with a soft, dry cloth. If you have something stubborn to remove, use a mild dish soap or detergent sparingly applied to a soft cloth. Don't use alcohol, ammonia, or other strong solvents.

Service Assistance: We suggest that you read the Limited Warranty completely to fully understand your warranty/service coverage. Please promptly complete and return the Warranty Registration Card. Also be sure to save the sales receipt in a safe place. It will be necessary for warranty service. If your CARVER Professional product should require service, you may contact the CARVER Professional Technical Service Department by calling (503) 978-3363 or by writing to us at the Factory address shown below. We will then direct you to the nearest in our national network of Authorized Warranty Service Centers or give you detailed instructions on how to return the product to us for prompt action. If you should have questions or comments, please write to the Factory address given below. Please include the model and serial number of your Carver Professional product, your complete address and a daytime phone number.

Field Configurable Gain Controls

PX850
PX1450

Note: The Carver Professional limited warranty does not extend to damage resulting from the following procedure if attempted by any person not specifically authorized by Carver Professional



CAUTION

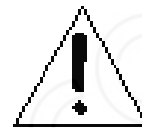

To move the gain controls from the front panel to the back panel (or vice versa):

1. Unplug amplifier from power source.
2. Remove top cover (9 screws). Do not allow debris, tools, or hardware to fall inside chassis.
3. Gently pull to remove control knobs from gain controls and remove hole plugs from opposite panel.
4. Remove the 4 screws from gain control circuit board.
5. Carefully move board to opposite panel stand-offs, being sure to keep connector cable free and untwisted.
NOTE: Gently bundle excess cable length and secure with tie wrap.
6. Screw board to threaded stand-offs. Do Not Over Tighten!
7. Put hole plugs in opposite panel.
8. Observing the position of the knob pointers, gently push the control knobs onto the gain controls, or leave off for screwdriver adjustment.
9. Replace top cover.

In Case of Difficulty

If you're having trouble or suspect a problem with the PX850/PX1450, try some simple troubleshooting before contacting an Authorized Carver Professional Dealer, Authorized Carver Professional Service Center, or Carver Professional Technical Service.

No Sound, No Power

This is usually an indication of a power supply problem, either the power line itself or the amplifier's power supply.

1. PX amplifier power is switched off.
2. Line cord is disconnected.
3. Poor fit between the plug and AC receptacle.
4. Power off at AC receptacle (check with tester or lamp).
5. The amplifier is plugged into a switched outlet. Verify that the outlet is live.
6. PX amplifier fuse has blown. Check and replace fuse.
7. The thermal breaker in the power transformer has opened. Allow amplifier to cool & the breaker will reset itself.

Power On, Low Output or No Output

Low or no output problems are usually signal-source, bad cable or partial output short circuit related.

1. The Input Level controls are set too low.
2. Move the input connections to another amplifier that you know is working to verify that it is not a source problem.
3. Check the speaker connections. Be sure that there are no small strands of wire touching similar strands coming from the other wire in the cable.
4. Make sure the speakers are functioning correctly.
5. If you are using bridged-mono mode, ensure that the Stereo/Mono switch is set correctly.
6. Use a voltmeter to determine if the power line voltage is dropping excessively when the amplifier is driven hard.

Playback Is Mixed with Hum

1. Check or replace the connecting cables.
2. Make sure that each screw terminal connection is tight.
3. Signal cables may have been routed too closely to AC cables, power transformers, motors or other EMI inducing device.
4. Try connecting another source to the power amplifier inputs. If the hum stops, the problem lies with the original source component.

Distortion

Distortion is usually caused by excessive loss in the input controls (the mixer/equalizer/crossover can't produce enough output), overdriving resulting in output clipping, or current limiting caused by excessively low load impedances.

1. Check the setting of the Input Level controls. If set too low, the preceding piece of equipment may not have sufficient output to overcome the loss.
2. Check the speaker connections and verify that all screw connections are tight and that there are no stray strands of wire to cause short circuits.
3. Verify that the total load impedance presented to the amplifier is within the limits described in this manual for the mode of operation selected.

Carver Professional

Service Department

P.O. Box 83189

Portland, OR 97283

Phone 503.978.3363 • Fax 503.978.3302

email: carverpro@imagina.com

Carver Professional reserves the right to improve its products at any time. Therefore, specifications are subject to change without notice.

Warranty Information

Professional Power Amplifiers: 5 years

PX850
PX1450

NOTE: The following warranty is exclusive to the United States and its possessions and territories. Please see your Carver Professional dealer or distributor for the correct warranty information in your area or locale.

WHAT IS COVERED:

THIS WARRANTY COVERS DEFECTS IN MATERIAL AND WORKMANSHIP ONLY. This limited Warranty DOES NOT extend to: 1) Damage caused by shipment, 2) damage caused by accident, misuse, abuse, failure to perform owner maintenance, or operation contrary to the instructions in the Carver Professional owner's manual, 3) units on which the serial number has been defaced, modified or removed and 4) damage resulting from modification or attempted repair by any other person than authorized by Carver Professional.

WHAT WE WILL PAY FOR:

Carver Professional will pay all labor and material expenses for items covered under this Limited Warranty. See the next section concerning shipping charges.

WHAT YOU MUST DO TO OBTAIN WARRANTY SERVICE:

In the event your Carver Professional product requires service, contact your Carver Professional authorized dealer/contractor **or** contact Carver Professional (ATTN: Customer Service Dept.) P.O. Box 83189, Portland, OR 97283, or call the Customer Service Department directly at (503) 978-3363. You will be directed to an Authorized Carver Professional Service Station or receive instructions to ship the unit to the factory. Please save the original shipping carton and packing materials in case shipping is required. **Please do not ship parcel post.** Include a complete description of the problem, the associated components and connections, and a copy of the purchase receipt. Initial shipping costs are not paid by Carver Professional. Return shipping costs will be pre-paid if repairs were covered by the scope of this warranty.

YOU MUST RETAIN AND PROVIDE YOUR SALES RECEIPT TO OBTAIN COVERAGE UNDER THIS LIMITED WARRANTY.

The warranty period begins from the date of the first consumer purchase from an Authorized Carver Professional Dealer. Any implied warranties for merchantability and fitness for a particular purpose required by any state law are limited in duration to the warranty period of your product. The warranty set forth above is exclusive and no other warranty written or oral is expressed or implied. Carver Professional specifically disclaims the implied warranties of merchantability and fitness for a particular purpose.

EXCLUSION OF CERTAIN DAMAGES:

In no event shall Carver Professional be liable for property damage, or any other incidental or consequential damages which may result from the failure of this product. If your Carver Professional product proves defective in material or workmanship, the liability of Carver Professional shall be limited to the repair or replacement, at the option of Carver Professional, of any defective part.

STATE LAWS MAY DIFFER:

Some states do not allow limitations on how long an implied warranty lasts and/or do not allow the exclusion or limitation of incidental or consequential damages, so the above limitations may not apply to you. This warranty gives you specific legal rights, and you may have other rights which vary from state to state.

OTHER IMPORTANT PROVISIONS:

Carver Professional reserves the right to make changes in design and improvements to its products without the responsibility of installing such changes to improvements on products previously sold by Carver Professional. We suggest that you attach your purchase receipt to this Warranty and keep both documents in a safe place. Thank you for your choice of a Carver Professional Amplifier.

Accessories

For the optimum connection of your PX amplifier, here is a sample of the many accessory products available from Carver Professional. For more information on these accessories, or to receive a full-line catalog of Carver Professional Accessories, see your Authorized Carver Professional Dealer/Contractor, or contact Carver Professional at 503-978-3344. Email: carverpro@imagina.com.

CONNECTORS

1/4" Connectors/Balanced	GS4MS5	TRS Plug Solder Cup type w/ 24kt Gold Plated Plug - Accepts 5.0mm Cable
	RS4MS5	TRS Plug - Accepts 5.0mm Cable
1/4" Connectors/Unbalanced	GS4MM5	Mono Plug Solder Cup Type w/24kt Gold Plated Plug - Accepts 5.0mm Cable
	RS4MM5	Mono Plug - Accepts 5.0mm Cable
XLR Connectors	GSXM7	Solder Type Male XLR w/ Adjustable Strain Relief - Accepts 7.0mm Cable
	RSXM7	Gunmetal Grey Plated Male XLR Connector - Accepts 7.0mm Cable
Spade Terminals	CP PRO8	Pro Series 7-9 Gauge Multi-Stud Spade
	CP PRO80	Pro Series 7-9 Gauge Slotted Spade
	CP PRO404	Pro Series 12-16 Gauge Spade
	CP PRO81	Pro Series 7-9 Gauge Slotted Right Angled Spade
Banana Plugs	CPA405	4.0mm Tighter Fitting Multi-Purpose Banana for 16-18 gauge
	CPA408	Crimp-on 4.0mm Banana Plug for 12-16 gauge
	CP ZPB1	Crimp-on 4.0mm Banana Plug for 8-12 gauge ZeroPoint Reference Cable
	CP Dual	Dual 4.0mm Banana Plug for 12-18 gauge
	CP PRO Dual	Pro Dual 4.0mm Banana Plug for 9-14 gauge
Neutrik™ Speakons™	CP NL4FC	4 Conductor Female Cable Mount
	CP NL8FC	8 Conductor Female Cable Mount

SIGNAL CABLE WITH CONNECTORS

- ZEROpoint PRO QLX-Quadralink Twisted Pair Balanced Grade w/ 1/4" TRS Plugs
- ZEROpoint PRO QLX-Quadralink Twisted Pair Balanced Grade w/ XLR to XLR
- Trans Balanced Pro OFC Cables w/ Dual 24kt Gold Plated GS Series 1/4" Plugs

SIGNAL CABLE BULK

- ZEROpoint Musical Reference Interconnect Cable-Sapphire Blue
- ZEROpoint Pro Twisted Pair Interconnect Cable
- ZEROpoint PRO QLX QuadraLink Interconnect Cable
- ZEROpoint TRX PRO - Interconnect Cable

SPEAKER CABLE WITH CONNECTORS

- Super OFC 2 Conductor Speaker Cable - 1/4" To Dual Banana
- Mondo Series 2 Conductor Speaker Cables 10,12,14,15 AWG - 1/4" Plugs
- Mondo Mult Series Ultra Flexible Round 13 AWG Multi Conductor Cable - Neutrik™ Speakons™
- Mondo Multi Series Ultra Flexible Speaker Snakes w/ 3' Fan Ends - various Connector combinations available

SPEAKER WIRE BULK

- ZEROpoint Musical Reference Speaker Wire - 2 and 4 conductor
- Mondo Series Ultra Flexible Round 2 Conductor Speaker Wire
- Mondo Multi Series Ultra Flexible Round 13 AWG Multi Conductor Speaker Wire

HANDLE OPTION

- PX 4HK - PX Handle Kit. 4" Black Handle with Mounting Hardware

For more information on these accessories, or to receive a full catalog of Carver Professional Accessories, see your Authorized Carver Professional Dealer/Contractor, or contact Carver Professional at 503.978.3344
carverpro@imagina.com