





The lightning flash with arrowhead symbol within an equilateral triangle is intended to alert the user to the presence of uninsulated "dangerous voltage" within the product's enclosure, that may be of sufficient magnitude to constitute a risk of electric shock to persons.



The exclamation point within an equilateral triangle is intended to alert the user of the presence of important operating and maintenance (servicing) instructions in the literature accompanying the appliance.

## Safety Instructions

**1. Read Instructions** — All the safety and operation instructions should be read before the Sunfire Component is operated.

**2. Retain Instructions** — The safety and operating instructions should be kept for future reference.

**3. Heed Warnings** — All warnings on the Component and in these operating instructions should be followed.

**4. Follow Instructions** — All operating and other instructions should be followed.

**5. Water and Moisture** — The Component should not be used near water - for example, near a bathtub, washbowl, kitchen sink, laundry tub, in a wet basement, or near a swimming pool, etc.

**6. Ventilation** — The Component should be situated so that its location or position does not interfere with its proper ventilation. For example, the Component should not be situated on a bed, sofa, rug, or similar surface that may block any ventilation openings; or placed in a built-in installation such as a bookcase or cabinet that may impede the flow of air through ventilation openings.

**7. Heat** — The Component should be situated away from heat sources such as radiators, or other devices which produce heat.

**8. Power Sources** — The Component should be connected to a power supply only of the type described in these operation instructions or as marked on the Component.

**9. Power Cord Protection** — Power-supply cords should be routed so that they are not likely to be walked upon or pinched by items placed upon or against them, paying particular attention to cords at plugs, convenience receptacles, and the point where they exit the Component.

**10. Cleaning** — The Component should be cleaned only as recommended in this manual.

**11. Non-use Periods**—The power cord of the Component should be unplugged from the outlet when unused for a long period of time.

**12. Object and Liquid Entry** — Care should be taken so that objects do not fall into and liquids are not spilled into the inside of the Component.

**13. Damage Requiring Service** — The Component should be serviced only by qualified service personnel when:

**A.** The power-supply cord or the plug has been damaged; or

**B.** Objects have fallen, or liquid has spilled into the Component; or

**C.** The Component has been exposed to rain; or

**D.** The Component does not appear to operate normally or exhibits a marked change in performance; or

**E.** The Component has been dropped, or its cabinet damaged.

**14. Servicing** — The user should not attempt to service the Component beyond those means described in this operating manual. All other servicing should be referred to qualified service personnel.

**15. To prevent electric shock**, do not use this polarized plug with an extension cord, receptacle or other outlet unless the blades can be fully inserted to prevent blade exposure.



Pour prévenir les chocs électriques ne pas utiliser cette fiche polarisée avec un prolongateur, un prise de courant ou une autre sortie de courant, sauf si les lames peuvent être insérées à fond sans laisser aucune partie à découvert.

**16. Grounding or Polarization —**

Precautions should be taken so that the grounding or polarization means of the Component is not defeated.

This apparatus does not exceed the Class A/Class B (whichever is applicable) limits for radio noise emissions from digital apparatus as set out in the radio interference regulations of the Canadian Department of Communications.

**ATTENTION —** Le présent appareil numérique n'émet pas de bruits radioélectriques dépassant les limites applicables aux appareils numériques de class A/de class B (selon le cas) prescrites dans le règlement sur le brouillage radioélectrique édicté par les ministere des communications du Canada.

	<b>WARNING:</b> THIS SUBWOOFER IS CAPABLE OF PRODUCING SOUND PRESSURE LEVELS IN EXCESS OF 113 dB. YOU MUST TAKE EVERY PRECAUTION TO PROTECT YOUR HEARING FROM PERMANENT DAMAGE.	
---	---	---

# Contents

Safety Instructions .....	2
Introduction .....	4
Features .....	4
Unpacking .....	4
Care .....	4
Overview .....	5
Control panel features .....	6
Installation .....	8
Connections .....	9
Location .....	10
System configurations .....	11
Adjusting the controls .....	15
Specifications .....	16
Troubleshooting guide .....	17
Limited warranty .....	19
Service assistance .....	19

To find out more about this and other Sunfire products, please visit our website: [www.sunfire.com](http://www.sunfire.com)

# Introduction

Dear Friend:

Thank you for purchasing my Sunfire True Subwoofer Architectural Signature. I hope you enjoy it and the music it makes as much as I have enjoyed creating it for you.

The big breakthrough features of the subwoofer are its uncanny tracking downconverter and its long throw, high back-electromotive force driver. Taken together, they provide this subwoofer with as much bass as you could get from several 15 inch drivers mounted in a cabinet the size of a small refrigerator.



# Unpacking

Your Sunfire Subwoofer should reach you in perfect condition. If you do notice any shipping damage, please contact your Sunfire Dealer immediately.

Gently lift out the unit and remove all the packing material. It is important to save all the packing materials and the box in case your subwoofer ever needs to be moved or shipped for repair.

Make sure that you keep your sales receipt. It is the only way to establish the duration of your Limited Warranty and it may come in useful for insurance purposes.

Please take a moment to fill out and mail the Sunfire Warranty Registration card. Also read the serial number located on the control panel and record it here:

Serial Number:
_____
Purchased from:
_____
_____
_____
Date:
_____

# Features

- High power, high efficiency amplifier
- Very low distortion
- Long throw, premium quality 12" driver
- Compact size
- Automatic signal-sensing turn-on and standby mode
- Line level unbalanced inputs
- Speaker level binding post inputs
- Line level high-pass outputs
- Flat/Video contour switch
- Continuously variable phase control
- Continuously variable crossover frequency adjustment
- Continuously variable volume level control
- Soft clipping circuit allows graceful overload and prevents speaker damage due to clipping
- Gold-plated inputs and outputs.

# Care

To maintain the speaker cabinet's finish, first unplug the power cord and then use a soft, slightly dampened cloth to clean the surfaces and finish off with a dry cloth.

To keep the large rubber surrounds soft and supple for 20 years or more, treat them with MINK OIL, available at most shoe repair stores. Rub a generous amount into the surrounds with a soft cloth about once a year (more often if you live in a dry climate). Make sure that you do not get any oil on the fabric grill.

If your Sunfire Subwoofer needs servicing, please read the Troubleshooting section on page 17. If a problem still persists, contact your nearest authorized Sunfire Dealer.

# Overview

Your Sunfire Subwoofer is designed to give you the best possible low-frequency sound quality for your home theater experience. It incorporates a tremendously powerful built-in amplifier and a pair of drivers to produce tight, floor-rumbling bass down to 16 Hz, that you can feel as well as hear.

The subwoofer has an adjustable high cut filter and a choice of speaker-level or line-level inputs for easy incorporation into existing systems, or as part of a subwoofer/satellite speaker combination.

## The Woofer

To have lots of bass requires moving lots of air. Your Sunfire Subwoofer's driver can move back and forth approximately five times more than a normal subwoofer. This gives it a lot of air moving capacity which allows for massive bass performance.

## The Amplifier

The large movement range of the driver creates greater air pressure inside the box than a conventional woofer. Therefore, the drive amplifier must be much more powerful than an ordinary woofer amplifier. In fact, it has to be so powerful that it is almost hard to believe.

The power amplifier within your Sunfire Subwoofer is capable of delivering over 1,500 watts into a 3.3 ohm resistor (the voice coil resistance of the subwoofer's driver). When the same full output is applied to the driver, however, the enormous back-electromotive force generated as a consequence of its large motion and giant magnet causes the current flow to be much less than if it were a 3.3 ohm resistor. It is this singular property of the driver that allows the woofer to be approximately ten times more efficient than a woofer this size would normally be. Hence, the actual average input power is substantially less than 1,500 watts, and is

approximately 150 watts for most musical material on the loudest passages.

A compressor circuit kicks in automatically if the input signal level reaches a level that would overload the driver. This maintains a ceiling on the output without clipping.

If the input signal is driven even further, a 'soft clipping' circuit is enabled. This allows the woofer to put more sound into the room to satiate the power hungry user, but without distortion or damage to the woofer. Thus, for explosive scenes in movies, this produces extremely high sound pressure levels (SPL) in your room without the woofer banging against its mechanical stops.

If you would like more detailed information regarding the subwoofer design, please call us and we will send you a copy of our subwoofer technical white paper, or you can view it on our website: [www.sunfire.com](http://www.sunfire.com).

Note: In this manual, the term "sub/LFE" is used to denote the subwoofer or Low Frequency Effects output, commonly found on home theater preamplifiers and receivers.

# Control Panel Features

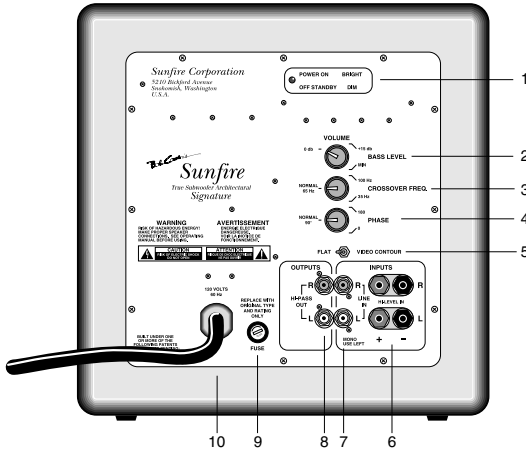

## 1. Power/Auto on Indicator

This light is bright when the subwoofer is on, and dim when the subwoofer is in its standby mode. This is controlled by the AUTO ON/OFF circuit. The presence of an audio signal turns the unit on. After approximately fifteen minutes of signal absence, the subwoofer will go to its standby mode.

The light will only go completely off when the unit is unplugged from the wall.

## 2. Bass Level

This control lets you match the output level of the subwoofer to the level of your satellite/main speakers. The subwoofer output will increase as the volume control is rotated clockwise. When you have just installed your system, turn this down first before turning on your subwoofer. This will prevent any loud surprises.

## 3. Crossover Frequency

This controls the high frequency cutoff point. With the control rotated fully clockwise, the subwoofer will reproduce frequencies up to 100 Hz. With the control fully counter-clockwise the subwoofer reproduces up to 35 Hz.

Rotate the control until the bass sounds natural. If the mid-bass sounds natural but you want more low bass, turn the crossover frequency down a little, then turn the volume control up by about the same amount. This increases the low-bass output while leaving the mid-bass output the same.

## 4. Phase Control

This control changes the relative phase of the subwoofer with respect to your other speakers. Use this control to help blend the subwoofer with the rest of your system. This is accomplished by adjusting the control in small increments as you listen for the most bass at your listening position. As a final trim, readjust the crossover and volume controls after the phase control has been set.

## 5. Flat/Video Contour Switch

When this switch is set to FLAT, the frequency response extends down to 16 Hz. This is the recommended setting for most audio and video applications.

When set to Video Contour, a low frequency roll-off is introduced commencing below approximately 30 Hz. This setting may be used if your

system or neighbors are disturbed by ultra low bass.

## 6. Speaker Level Inputs

Under normal conditions, the preferred connection is through the Low Level inputs. If this is difficult or not possible in your system, then you can use the Speaker Level inputs. Also, if you experience excessive noise or hum with the Line Level inputs, often a simple change to the High Level inputs will result in a lower background noise level.

Connect to the speaker-level output of your amplifier or receiver using speaker wire (see page 14). The binding posts can accept bare wire, banana, dual-banana or spade connections.



Your amplifier or receiver **MUST** have common grounded outputs, or it will be damaged if connected to these High Level inputs.

## 7. Line Level Inputs

Connect with RCA type patch cords to the line level outputs of your receiver or preamp. Here are two examples:

If your preamplifier or receiver has a single sub/LFE output, connect it to the subwoofer's left input jack (see page 11). There is no need to use the subwoofer's right input jack.

If you want to run your main/satellite speakers full range, use a "Y" adapter at the preamplifier outputs (see page 12). In this way, you can send the preamplifier's output signal to your main amplifier and to the subwoofer at the same time.

## 8. High Pass Outputs

Line level high-pass output signals are available at these jacks. These outputs are active whenever a signal is hooked up to the inputs of the subwoofer. The high-pass crossover is a passive

network with a fixed crossover frequency of 70 Hz and a 6 dB per octave slope.

We recommend using this high-pass function with main/satellite speakers that are small and not designed to reproduce low frequencies. If your main speakers are capable of operating full range, then you will not need to use the high-pass function.

To use the High Pass outputs, connect the preamp outs of your preamp/receiver to the subwoofer's Line Level inputs using good quality RCA type patch cords. Then connect a second patch cord from the subwoofer's High Pass outputs to the inputs of your main amplifier (see page 13). This will allow your main speakers to operate at frequencies above 70 Hz and the subwoofer to operate at frequencies below 70 Hz.

## 9. Line Fuse

The standard 120 Volt True Subwoofer is supplied with a conservative 6 1/4 amp slo-blo type fuse to protect the electronics.



Always unplug the power cord before inspecting or changing the fuse. Never use a fuse with a larger current rating than 6 1/4 amps.

## 10. Power Cord

The standard 115 Volt Subwoofer can be plugged into any 120 Volt 60 Hz outlet with a circuit rating of 10 amps or more (a typical home circuit is rated at 15 amps).



**NOTE:** It is normal to hear an audible "snap" when the power cord is plugged in to a live outlet.

# Installation

Observe the following general precautions and read the safety instructions on pages 2 and 3 before using your Sunfire Subwoofer.

- Never open the cabinet or remove the metal control panel as this might result in an electrical shock to you or damage to the unit.
- Protect it from prolonged exposure to direct sunlight and other direct sources of heat, such as heating vents and radiators.
- To prevent fire or shock, do not expose the unit to rain or moisture. If fluid or a foreign object should enter the unit, immediately turn off the power and contact your Sunfire Dealer.
- Avoid excessive exposure to extreme cold or dust.
- Do not place heavy objects on top of the unit.
- Do not place the subwoofer with its control panel against the floor.
- If you wish to place your woofer so the drivers face the floor and ceiling, thereby moving up and down, use at least 1-1/2 inch high spikes or feet for support. They may be attached either with screws or self-stick backing. This arrangement will impart substantial house and floor shaking motion.
- Four extra heavy, shock absorbing rubber mounting feet have been included. If your woofer tends to wander about slightly while in use, place these feet just inside the existing feet positions. These shock absorbing mounts will let the woofer rock freely, thereby absorbing low frequency rocking energy, allowing it to adhere solidly to the floor. To move the woofer along the floor, rotate it onto one edge and it will slide along easier.

## Heat rise

- Allow adequate ventilation around the metal control panel of the subwoofer.
- Do not let anything come into contact with the panel and keep at least two inches away from any walls.

The metal control plate serves as the amplifier heat sink and also as a conduit to remove internal heat to the outside and into the atmosphere. It can reach temperatures of 60 degrees C, which will feel hot to the touch, using nerves of flesh and blood as temperature sensors. As uncomfortable as it may feel, 60 degrees C cannot burn you, and in fact is almost cool to copper, silicon, steel, and aluminum, the materials from which your woofer is constructed.

## AC Power Considerations

Ensure that the unit is plugged into an outlet capable of supplying the correct voltage specified for your model.

Unplug your subwoofer's power cord from the electrical outlet if it will be left unused for a long period of time.



**NOTE:** Never remove the ground pin from any power cords. This is very dangerous.

Route the power-supply cord so it is not likely to be walked on or pinched by items placed upon or against it, especially at plugs, convenience receptacles, and the point where it exits from the unit.

## Magnetic Fields

We recommend that you place your woofer further than two feet away from your TV, VCR, tape deck or computer, so the speaker's magnet won't distort the colors of your TV picture or erase your video tapes, audio tapes or computer discs.



# Connections

Please consider the following when setting up your new system :

- Before making or changing any connections, ALWAYS make sure that the subwoofer is unplugged from the wall and your other components are turned OFF. Also turn down the volume control of the subwoofer and your preamplifier or receiver.

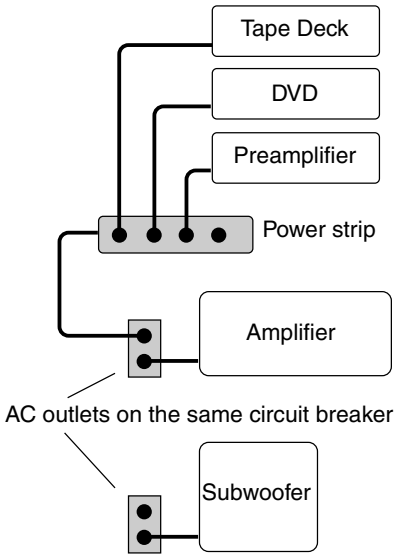

- This diagram shows all the low power components sharing a power strip which is connected to the same outlet used by the amplifier.
- The subwoofer is connected to an outlet on the same circuit breaker, provided that the total system current draw does not exceed the breaker current rating.
- This arrangement will reduce the possibility of an audible hum in your system caused by a ground loop.

- Whenever possible, keep the powercords away from the signal cables or speaker wires to prevent any hum or interference being heard in the speakers.
- Choose reliable, high quality interconnect cables, also called patch cords or RCA cables. They should be fully shielded and as short as possible for the job. The longest cable in your system will likely be to the subwoofer, so choose a good quality brand.
- Some patch cords can be a very tight fit and there is usually a preferred method of getting them off. Some have to be removed with a twisting action. Be gentle or you may damage the jacks of the subwoofer or your other components.

## Speaker Level connections

- The subwoofer's Speaker Level inputs can accept speaker wires with banana, dual-banana, bare wire or spade terminals. If you have banana type connectors on your speaker wire, make sure that you tighten the binding posts before inserting.
- Make sure that the negative speaker wires never touch the positive wires as this will short out and possibly damage your amplifier or receiver.



The subwoofer's two negative posts are joined internally (common-grounded). Your amplifier must also be internally common-grounded or you cannot use this connection. Contact the manufacturer of your amplifier to make sure its outputs are common grounded.

# Location

Placing your Sunfire Subwoofer in a corner of your room will produce optimum performance. Experiment with at least two corners and then decide which is the best.

Although low frequencies are non-directional, factors such as room reflections, standing waves, resonance and absorption strongly affect your subwoofer's performance.

Moving the subwoofer from one corner to another can have a major effect on the bass response.



Remember to keep it at least two or three feet away from any TV screen, computer, VCR or magnetic tapes and discs. This will reduce the chance of the magnetic fields upsetting the TV screen or erasing your magnetic media.

Also position the control panel so that it is not touching anything and can receive good ventilation.

## Using Two Subwoofers

If you wish to use two woofers, the sound output will double (an increase of 6 dB). Locate the woofers with one in each corner and experiment with the location and phase control to achieve the best bass response.

Always drive each woofer through the Left/Mon input even though you are driving one woofer with a right channel drive and the other with a left channel drive. If your preamplifier has a single sub/LFE output, use a Y cable to split it into two outputs.

# System Configurations

The following pages show some typical connections that you might make in your installation. They show how the inputs and outputs of the Sunfire Subwoofer are connected to your preamplifier or receiver.

## Connections to a preamplifier's subwoofer output

If your preamplifier has a subwoofer output (often labeled LFE for Low Frequency Effects), it can be connected to the subwoofer's Left (Mono) input as shown. This is the simplest and recommended connection. A receiver with a sub/LFE output can be connected in the same way.

The subwoofer will play the low frequency range and the other speakers will play the frequency range delivered to them by your amplifier.

If you have a home theater preamplifier, it may have an independent subwoofer volume control. Make sure this is correctly adjusted, and that the Sunfire Subwoofer's crossover frequency is set to 100 Hz. This is by no means an iron-clad rule, rather it is a good starting point. (See the crossover frequency control details on page 6 and adjustments on page 15).

You can set the subwoofer's Bass Level control to 0dB, and then use the preamplifier's subwoofer level control for normal and routine adjustments.

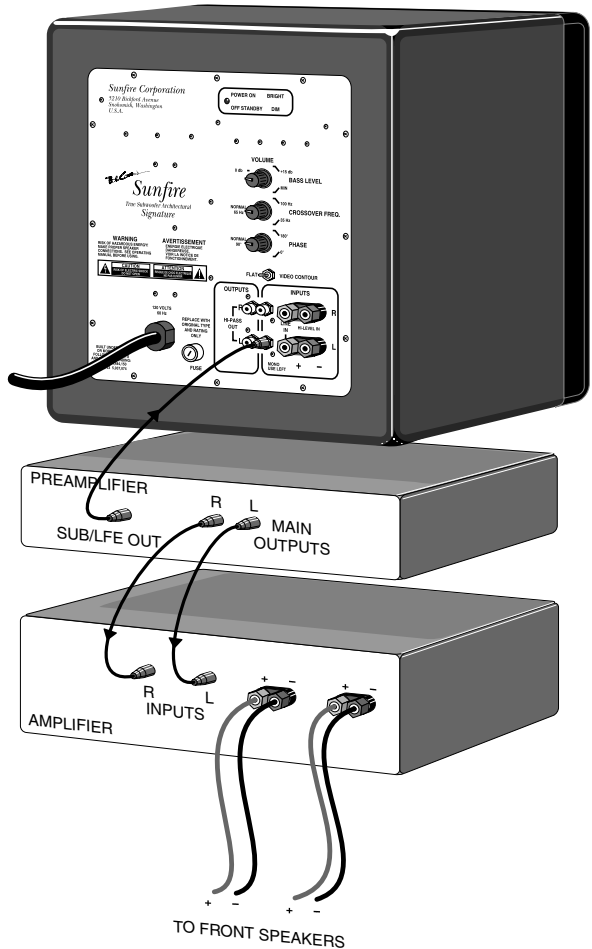

# Connections to a preamplifier using Y cables

If your preamplifier does not have a sub/LFE output, you can use “Y” cables to send its main outputs to both the subwoofer and your amplifier.

The subwoofer will play the low frequency range and your front speakers will play the full range.

Although bass is commonly distributed evenly between left and right channels (L+R bass), movie soundtracks often contain differential (L-R) bass. The opening scene in “Top Gun”, for example, has loads of L-R bass information. If this is not preserved, the bass in these scenes sounds anemic. The Sunfire Subwoofer utilizes differential gain on the left and right inputs to retain both the L+R and L-R information. Therefore, systems which do not have a dedicated sub/LFE output should use **both** the left and the right inputs as shown, for the greatest bass impact.

An alternative connection method without using Y cables is shown on the next page.

If your preamp/receiver has a dedicated sub/LFE output, then only the Left (Mono) input is used, as shown on the previous page.

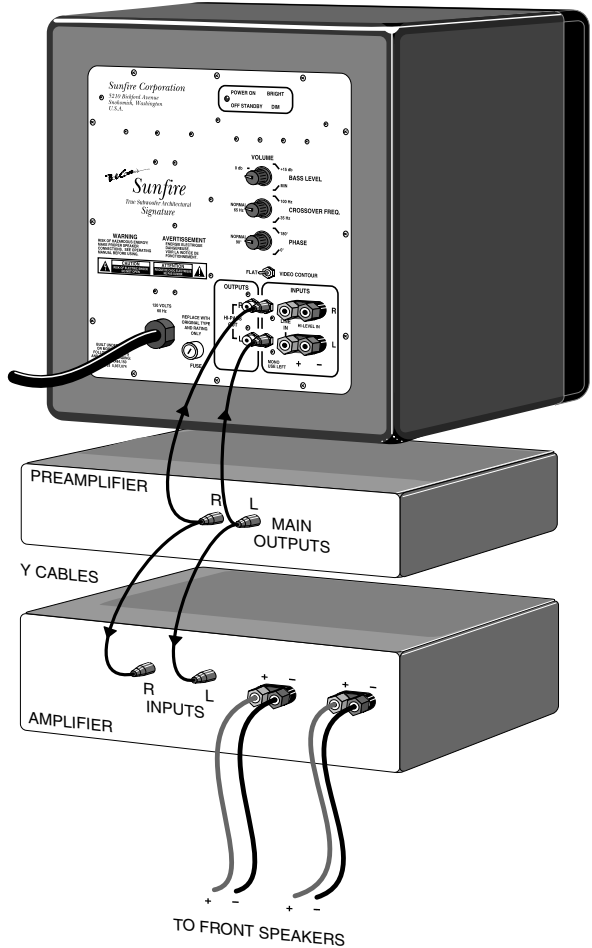

# Using the line level high-pass outputs

If you are using a preamplifier which does not have a sub/LFE output, you can send its left and right front output into the subwoofer's Line Level inputs and then connect the subwoofer's High-Pass outputs to the inputs of your amplifier.

The subwoofer will play the low frequencies and your amplifier and front speakers will play the frequency range above the subwoofer's fixed high-pass crossover point.

The signals coming out of the subwoofer's high-pass outputs are not affected by any of the controls. They are just a copy of the signals going in except that the low bass is filtered out. This uses the subwoofer's passive crossover network, rather than the active network and controls.

This connection is beneficial when using small mini-monitor or satellite speakers and/or an amplifier with limited power output.

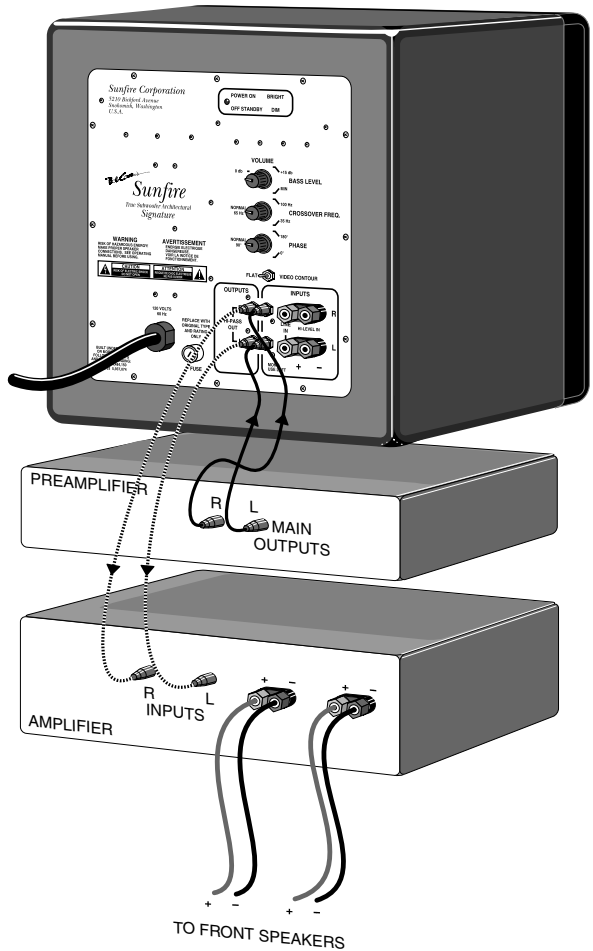

## Using the speaker level inputs

If you are using a receiver which does not have a subwoofer output or line level outputs (pre-outs), you can connect its speaker outputs to the subwoofer's Speaker-Level inputs. The front speakers can still be connected to your receiver.

The subwoofer's internal amplifier supplies the power to reproduce the low frequency range. It receives a sample of the signal going to your front speakers. (An insignificant fraction of your receiver's power is transferred to the subwoofer).

There is no need to use the Speaker Level inputs if you are using a separate amplifier and preamplifier. Such systems are best connected using the Line Level inputs as shown in the previous diagrams.

If you are using the Line Level inputs and there is a excessive amount of noise or hum present, using the Speaker Level inputs may yield a lower background noise level.



Your receiver **MUST** have common grounded outputs, or it will be damaged if connected to the subwoofer's Speaker Level inputs.

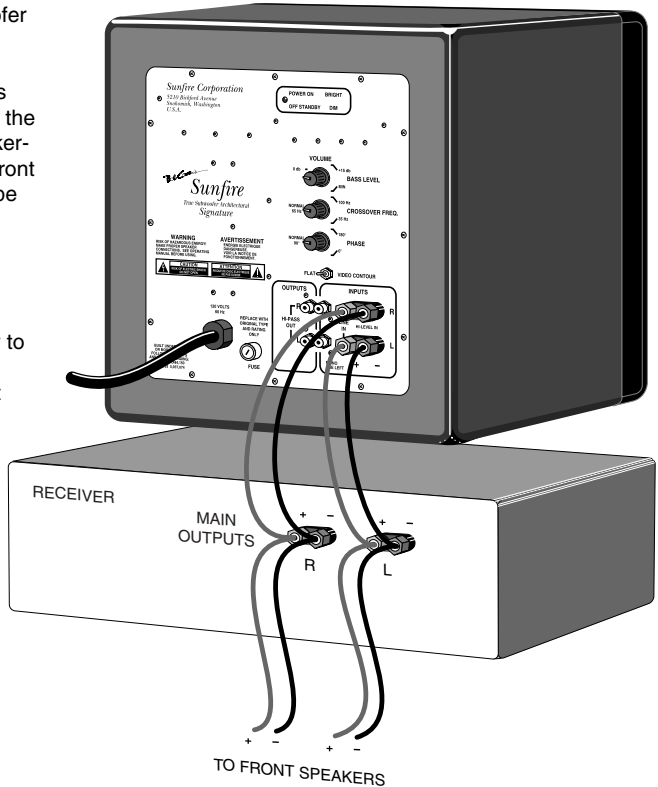

# Adjusting the controls

There are two main methods for adjusting the level, crossover frequency and phase of the Sunfire Subwoofer to match a system:

- Bob Carver's preferred method: By listening and making the adjustments to suit your taste.
- Laboratory method: By measuring the output and adjusting for a flat frequency response.

Excellent results can be obtained if you make the adjustments based on simply listening. This is Sunfire's preferred method as it allows the system to be voiced based on what sounds the best, whereas laboratory-flat frequency response can often be clinical and less than exciting.

The following procedure is for those who prefer a more methodical and scientific approach. This excerpt is from "The Audio Critic," issue 24, page 31, written by contributing editor David Rich, and is reprinted here with their kind permission.

You will need a test CD with low-frequency warble tones, and a sound pressure-level meter. The Radio Shack® SPL meter will do fine, as will the *Stereophile*® test CD.

"Step 1. Disconnect the subwoofer and run the main speaker with a tone in its passband (80-100Hz). Measure the level.

Step 2. Disconnect the main speaker and reconnect the subwoofer. Set the subwoofer to its highest crossover frequency. Set the level control of the subwoofer to give the same sound pressure level with the same tone you used in Step 1.

Step 3. With both the subwoofer and the main speaker connected, measure the level of the tones at the available frequencies. Because the crossover is set too high, you will have a peaked response. Adjust the crossover control to get the smoothest response.

Step 4. Use the phase control to make the response even smoother. It has its biggest effect at the crossover frequency. You can iterate between the crossover and the phase controls. Keep your hands off the level control! It was set correctly in step 2.

Step 5. Listen to the subwoofer. Resist all temptations to turn up the level control. Play something with really deep bass to confirm that your subwoofer is working."

## Control settings

Use this drawing to record some of your favorite settings.

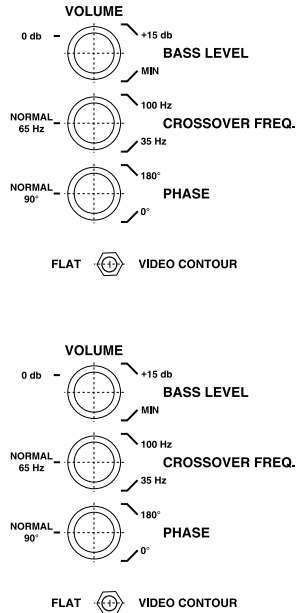

# Specifications

## Amplifier Output

1,500 Watts rms (3.3  $\Omega$  impedance)

## High Cut Filter

35 Hz - 100 Hz adjustable.

## Frequency Response

16 Hz - 80 Hz (+/- 3dB)

Low pass is -6 dB @ 80 Hz

## Power Line Voltage

AC 120 V/60 Hz

## Dimensions

13" x 13" x 13.9"

## Weight

50 lbs

## Finish

Black anodize and black lacquer.  
Removable fabric grill.

## Line power consumption:

550 Watts average, at maximum continuous output, 16 Hz to 100 Hz  
8 Watts at idle.

## Output levels:

Greater than 113dB peak SPL (includes room gain) from 16 Hz to 100 Hz.

Measurement method is one meter, anechoic, including room gain.

A typical Sunfire subwoofer can be expected to 'best' its specified minimum peak SPL by several decibels.

## Input sensitivity for full output:

250mVrms from left input with volume control at 0dB, 60mVrms with volume control fully clockwise\*

0.75Vrms from right input with volume control at 0dB, 200mVrms with volume control fully clockwise\*

## Input impedance:

12K $\Omega$  for Line-Level inputs

15K $\Omega$  for Hi-Level inputs

## Driver:

Extra large magnet and long throw mechanical design yield very high back-emf. The result is extraordinarily high operating efficiency – that is, more acoustic output for each watt of input.

## Internal system gain:

50dB from left input jack to speaker with the Bass Level control at 0dB, 62dB with the control fully clockwise\*

40dB from right input jack to speaker with the Bass Level control at 0dB, 52dB with the control fully clockwise\*

\* The Sunfire Subwoofer utilizes differential gain on the left and right inputs to retain both L+R and L-R information.

© 2002 Sunfire Corporation.  
All rights reserved. Sunfire Corporation reserves the right to improve its products at any time. Therefore, specifications are subject to change without notice.

Manual part number 913-009-00 Rev D



# Troubleshooting

The Sunfire Subwoofer is expertly designed and built to provide years of trouble-free performance. Most problems that occur can usually be solved by checking your setup or making sure that the components connected to the amplifier are on and fully operational.

The following information will help you deal with common problems you may experience during normal use. If a problem still persists, please contact your Sunfire Dealer for assistance.

## Not enough bass

- Check that the input connections are going to the input terminals and not the output terminals. In other words, the connections from your preamplifier must go to the subwoofer's line level inputs instead of the line level high pass outputs. If they are connected to the outputs by mistake, the bass will be weak but the subwoofer will still function.
- If your preamplifier has a single subwoofer/LFE output jack, make sure it connects to the subwoofer's Left (Mono) input. If the bass is still not enough after checking all the remaining points, use a Y cable to connect the preamplifier's single subwoofer/LFE output to the subwoofer's right and left inputs.
- Make certain the woofer is in a corner location, firing at 45 degrees into the walls formed by the corner. This is not absolutely essential, but will maximize the bass output and give the smoothest possible response. If you place the unit so its driver is firing into one of the walls, leave three inches of clearance between the driver and the wall.
- Home theater preamplifiers usually have a way of adjusting the level of the subwoofer/LFE output, either using a remote control or with a small volume

knob on the back panel. Make sure that this is adjusted correctly.

- If the preamplifier's subwoofer/LFE output has an adjustable crossover frequency, make sure that the subwoofer's own crossover point is set higher or part of the bass range will be missing.

## Not enough bass in a 5.1 system

- 5.1 home theater preamplifiers usually have a bass management system which allows the bass to be redirected among your speakers. For example, the bass normally present in the front speakers can be redirected to play in the subwoofer, or the subwoofer can play the bass from all the speakers, in addition to its dedicated LFE (low frequency effects) channel. Make sure that all of the bass management options are correctly set. The preamplifier may have a way of turning the subwoofer output off entirely, so check that it is always on.
- Check that the preamplifier calibration procedure is correctly adjusted. Usually, the preamp will send a test tone through all the speakers in your system, allowing you to adjust (trim) the volume of each channel until they are all playing at the same level.
- If the bass is weak only when playing 5.1 surround sources, check that your preamplifier is correctly set to decode the 5.1 surround modes, such as Dolby Digital or DTS.
- Some DVD discs have a menu which allows you to select which soundtrack to play. Check that the correct 5.1 surround audio soundtrack is selected, otherwise it may just play stereo into your preamp and you won't get the true LFE signal into the subwoofer.

## Hum

Adding any component such as a subwoofer to an existing system will often give rise to a hum which wasn't there before. Your first thought may be that the subwoofer has a problem, but this is more than likely caused by a "ground-loop" in your system.

Follow these steps to isolate the main cause of the ground-loop hum (there may even be more than one cause).

- Try to have all of your equipment on the same electrical outlet or circuit, see page 9 for more details.
- If your subwoofer is a fair distance away from your other equipment, you may use a 15 amp extension cord as long as it has a ground connection.



**NOTE:** Never remove the ground pin from any power cords. This is very dangerous.

- Turn off all components in your system, including the subwoofer, amplifiers and the preamplifier, before disconnecting or connecting cables.
- First remove every connection from the subwoofer to the rest of your system. Plug the subwoofer power cord back in and check for the hum. If it is still there, try plugging it into a different outlet in case it is picking up interference on the AC line.
- If you have followed the above guidelines for the power connections and a hum is still present, then there is one very common problem to consider: a "ground-loop" introduced by connecting a cable TV line to a VCR or TV, which is then connected to the preamp. This can be addressed as follows:
- Disconnect all cables which come from outside the room, such as cable TV, satellite TV, or roof top antennas. Make sure that they are disconnected where they first enter the room, so they are making no connection to your preamplifier, TV, or any other component. If the

hum is caused by the cable TV line, then you will need a "ground-loop isolator." This is an inexpensive device fitted in line with the coaxial cable feed.

- If the hum persists, disconnect all the source components one at a time from the back of the preamplifier until you identify the problem.
- If you are using the subwoofer's Line Level inputs and there is a excessive amount of noise or hum present, using the Speaker Level inputs may yield a lower background noise level.
- Ground-loop isolators are available for audio lines and video. Once you have identified which components are causing a problem, you can fit the isolators between the component and the preamplifier.

## The subwoofer won't turn off

- The subwoofer should turn itself off after approximately fifteen minutes with no audio signal present. If not, check there is no background hum. The subwoofer may sense hum as a small signal and stay on. See the above hints to eliminate the hum.

## The subwoofer won't turn on

- The subwoofer's volume control may be turned down or no signal is received from your preamplifier.
- Check the input connections.
- Check the mode switch on surround systems to be certain that a bass signal is being sent to the subwoofer.

## Audible snap from outlet

- When the subwoofer is initially plugged into the wall, there is an in-rush current surge as the power supply capacitors charge up. This may give rise to an audible snap from the outlet as the plug is inserted. This can be avoided by plugging the subwoofer into a switched outlet or switched power strip (rated at 15 Amps or more).

# Limited Warranty

Sunfire Corporation is proud of its products which have been built with care using advanced technology and premium component parts. Your unit has been crafted to perform properly for many years. Sunfire Corporation offers the following Warranty to you, the owner of a new Sunfire product:

The Sunfire Corporation Warranty for the True Subwoofer Architectural Signature is in effect for TWO years from the date of original retail purchase. The Sunfire Corporation Warranty covers defects in materials and workmanship. The following, however, are excluded:

- a) Damage caused during shipment.
- b) Damage caused by accident, misuse, abuse of operation contrary to the instructions specified in the Sunfire Corporation user's manual
- c) Units where the serial number has been defaced, modified or removed,
- d) Damage resulting from modification or attempted repair by any person not authorized in writing by Sunfire Corporation.

The Sunfire Corporation Warranty extends to the original owner or subsequent owner(s) during the two year warranty period so long as the original dated purchase receipt is presented whenever warranty service is required.

All implied warranties, including warranties or merchantability and fitness for particular purposes, are limited in duration to the two year length of this Warranty, unless otherwise provided by state law.

Sunfire Corporation's liability is limited to the repair or replacement, at our option, of any defective product and shall not in any event include property or any other incidental or consequential

damages which may result from the failure of this product.

Some states do not allow limitations on how long an implied warranty lasts and/or do not allow the exclusion or limitation of incidental or consequential damages, so the above limitations or exclusions may not apply to you.

This Warranty gives you specific legal rights, and you may also have other rights which vary from state to state. We suggest that you attach your purchase receipt to this Warranty and keep these in a safe place. Thank you for your choice of a Sunfire Corporation product.

## Service Assistance

We suggest that you read the Limited Warranty completely to fully understand your Warranty/Service coverage.

If your Sunfire Corporation product ever requires service, write to us, or call:  
Sunfire Corporation  
Technical Services Department  
P.O. Box 1589  
Snohomish, WA 98290  
Tel (425) 335-4748  
Fax (425) 335-4746

You will be directed to an authorized Sunfire Corporation Service Station or receive instructions to ship the unit to the factory. Please save the original shipping carton and packing materials in case shipping is required. Please do not ship Parcel Post.

**NOTE:** Before sending in your unit for repair, you must call Sunfire for return authorization.

Include a complete description of the problem, indicating how you have it connected, the associated equipment in your system and a copy of your purchase receipt. Initial shipping costs are not paid by Sunfire Corporation; return ground shipping costs will be prepaid if repairs were covered by the scope of this Warranty.

*Bob Carver's*  
**Sunfire**  
*...from his mind & soul*

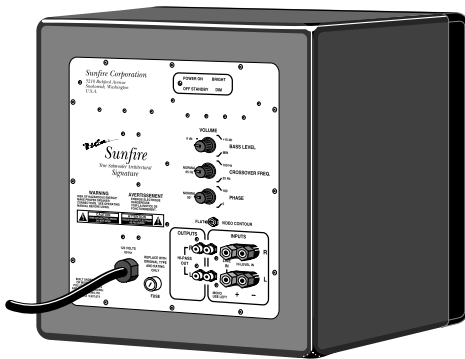

*True Subwoofer Architectural  
Signature*

*Sunfire Corporation  
P.O. Box 1589  
Snohomish  
WA 98291*

